

AZTEC-ATX4 User Reference Manual







SPECIFICATIONS

Model No	AZTEC-ATX4	AZTEC-ATX4
Motherboard	Support ATX M/B	Support SBC with Backplane
Slots	Offer 7 expansion slots	Offer 10 expansion slots
Drive bay	1x 5.25", 1x slim DVD-RW, 2x 3.5" (Option: 2x 5.25", 1x slim DVD-RW, 1x 3.5")	
Display	17" TFT LCD Monitor, 1280x 1024 Anti-reflection tempered strengthen glass	
VGA	AD conversion board, DVI interface (Option VGA)	
KB/MS	Industrial multi-languages Keyboard/ touchpad Operating Life of Keys: 8 million cycles Keyboard Layout: CH, FR, GR, KR, RU, SP, UK, US	
Power Supply	PS2, 650W, 100~240VAC, Auto switch	
Construction	Rugged Aluminum Construction with shock absorbing rubber corners	
Speaker	Built-in amplified 2x 3W speakers	
Dimension	433Wx 346Hx 227D mm (17.05"x 13.62"x 8.9")	
Weight	12 kgs	
Carrying Case	Padded carrying case with wheels	

ENVIRONMENTAL FACTORS

	Operating	Non-Operating
Temperature	0°C~50°C	-20°C~60°C
Relative Humidity	10%~90%	10%~95%
Shock	10g, 11ms, half-Sine	30g, 11ms, half-Sine
Vibration	10-500Hz (0.4 Grms)	10-500Hz (1.12 Grms)
Approval	CE, FCC, RoHS	

OPTIONS

VGA Interface	
	<ul style="list-style-type: none"> • DVI Interface cable for DVI Graphic card
	D-sub 15pin VGA interface cable
Touch Screen	
	<ul style="list-style-type: none"> • None
	Touch Screen
Drive Bay	
	<ul style="list-style-type: none"> • 1x 5.25", 1x slim DVD-RW, 2x 3.5"
	2x 5.25", 1x slim DVD-RW, 1x 3.5"
LCD Display	
	<ul style="list-style-type: none"> • 17" TFT LCD display, 1280x 1024 resolution
	17" TFT LCD display, 1920 x 1200 resolution

Standard Accessory Kits

<i>AZTEC-ATX4</i>			
Model	Accessory Kit SKD		Qty
<i>ARP 670</i>	1	AZTEC Portable Computer Chassis	1
	2	Carrying Case with wheels	1
	3	User's Manual	1
	4	Power Cord	1
	5	Anti-Static Bag	1
	6	Screw Pack (stabilizer)	1
	7	Stabilizer Supports Pack	1
	8		
	9		



Carrying Case with Wheels

1.0 Introduction

Version: 2010.12

AZTEC features:

- Rugged Aluminum Construction with shock absorbing rubber corners
- Built-in 17" LCD display with tempered glass, 1280x 1024
- Designed for Standard ATX M/B (7 slots)/ SBC with Backplane (10 slots)
- Offer 7/ 10 full length slots expansion capability
- Industrial multi-languages keyboard with touchpad
- PS2 650W power supply, 100~240VAC
- Offer 1x 5.25", 1x slim DVD-RW, 2x 3.5" drive bays
Option: 2x 5.25", 1x slim DVD-RW, 1x 3.5" drive bays
- Anti-reflection tempered glass protect LCD
- Carrying case to manage portable PC with ease

The AZTEC is a robust portable computer built using heavy duty metal to provide tough, go-anywhere unit ideally suitable for test and measurement applications. Its compact size supports standard ATX motherboard (AZTEC) and SBC with Backplane (ARP670-S), offer 7 or 10-slot for add-in cards, and built-in a SXGA resolution 17" TFT LCD display make it a high performance field solution. Functional practicality combined with the simple and polished design, the AZTEC with its extra-rugged construction to sustain bumps and impacted blows is the most cost-effective, durable and efficient portable solution for your needs.

Applications: Military, Industrial automation, Digital TV test & analysis, Mobile Computing, Outdoor Computers, video conferencing, E-learning, Speech Technologies, Portable Workstation, Telemedicine, Multimedia, Mission Critical Computing

AZTEC supports standard ATX MB, offer 7 expansion slots



AZTEC supports SBC+ PBP, offer 10 expansion slots

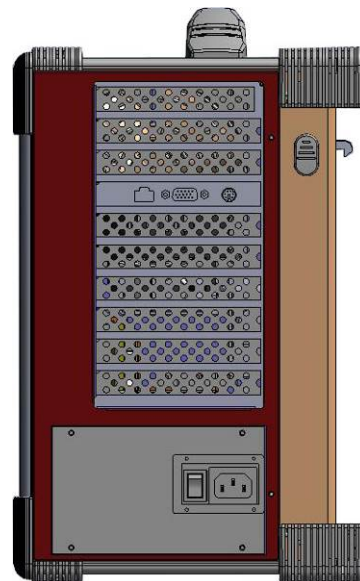

2.0 Operation

1. Releasing Keyboard from main unit by pushing up the 2 taps located on both side of the chassis to release the locking mechanism, and then pull out the keyboard.



2. You have the option of leaving the keyboard attached to the chassis or they can be release independently from the chassis by pushing the two levers inward to release the lock.

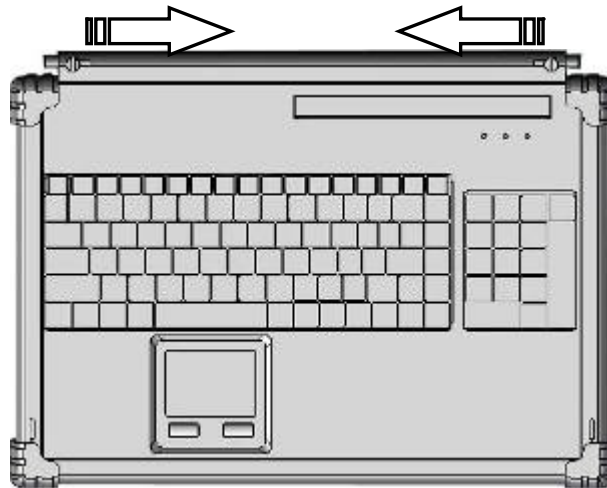

3. Connect the RJ-45 keyboard/touchpad cable to the front bottom right corner of the chassis. Make sure the pin direction is correct when inserting.



4. You can flip the 2 feet located underneath the chassis outward to help create an angle for the chassis for viewing comfort.

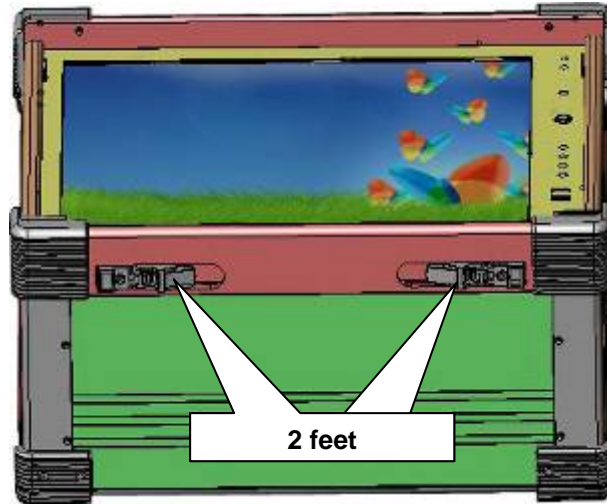

5. Connect the power cable outlet into the power supply unit

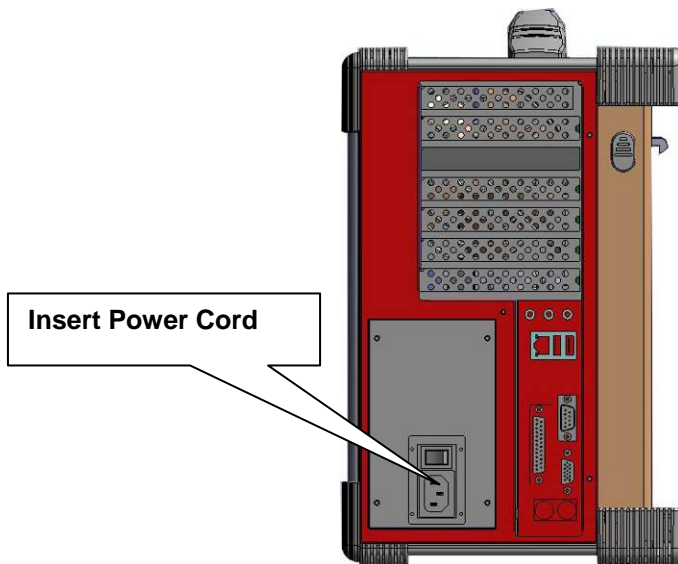

6. Press the power switch located on the front panel of the chassis to power up the unit. There have indicator LED lights for Power and HDD activity, 2x USB in the front

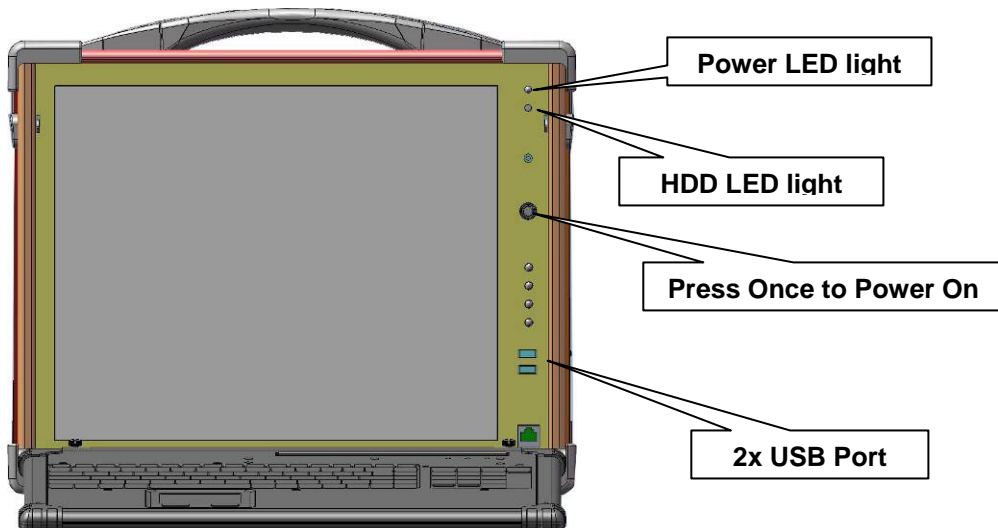

7. Access the available expansion slots on the left side of the chassis.

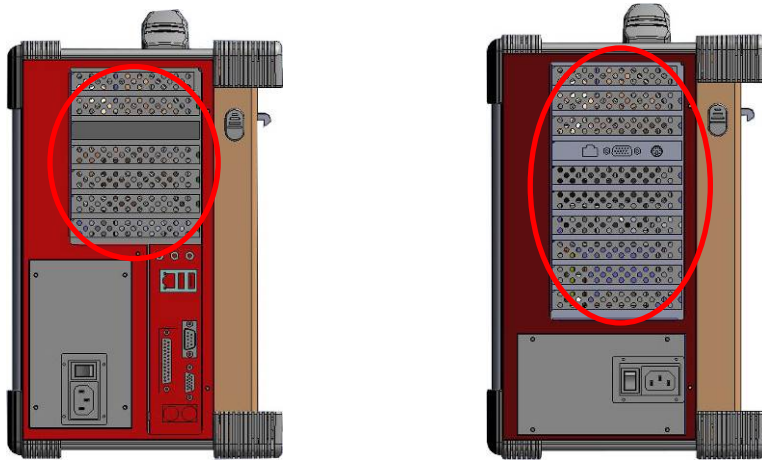

8. AZTEC provides 1x 5.25", 1x slim DVD-RW, 2x 3.5" drive bays
And 2x 5.25", 1x slim DVD-RW, 1x 3.5" drive bays (option)

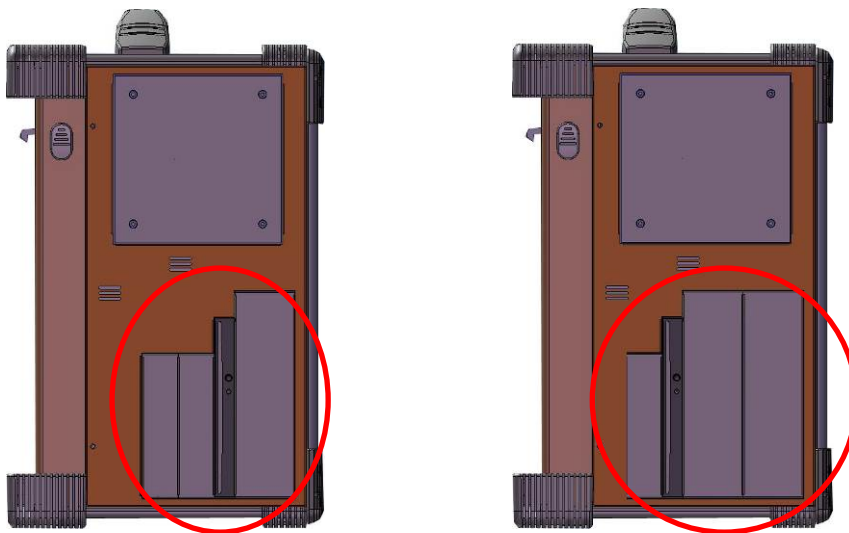

9. Full function keyboard and touchpad surface act as input for the system.

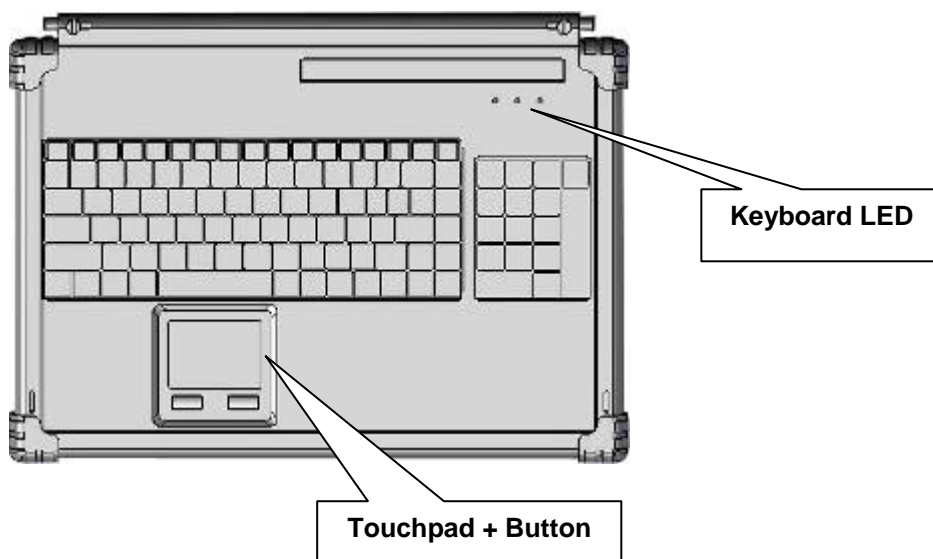

3.0 Internal Hardware Access

Be sure power cable is not connected to the system before proceeding

1. Open Back Cover

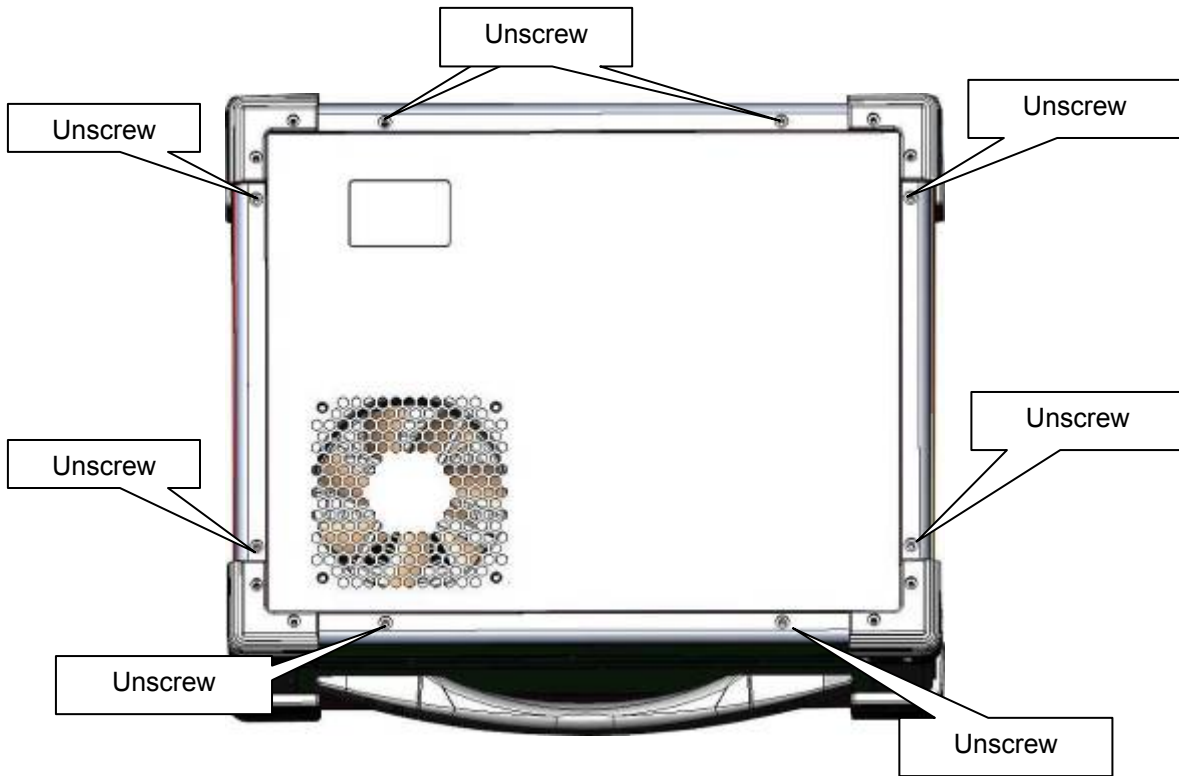

2. Remove the Card stabilizer bar

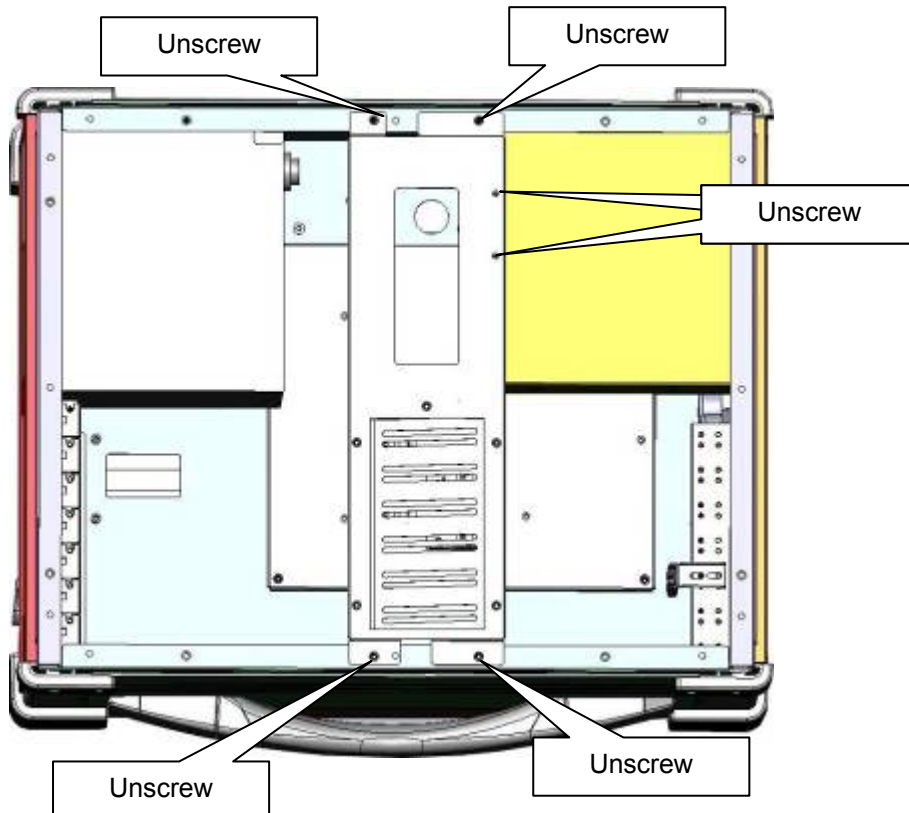

3. Remove the drive bay

3.1 Remove the right side cover

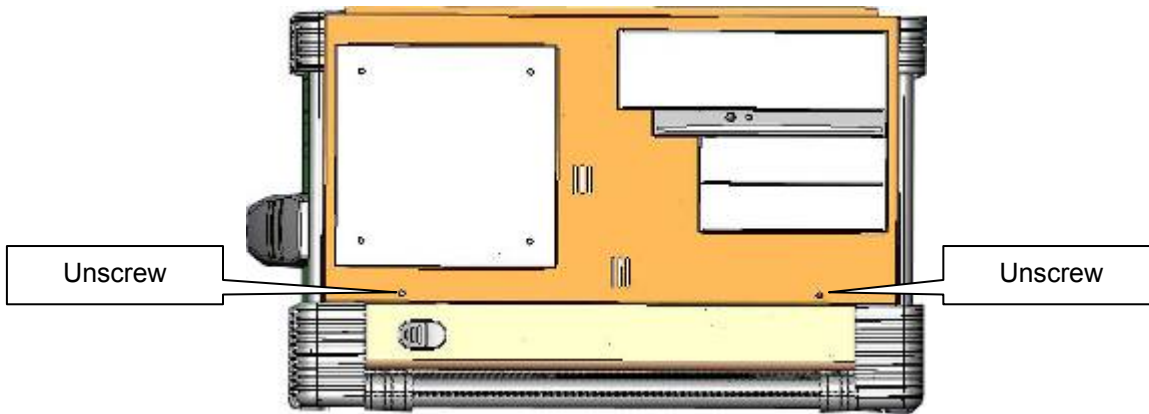

3.2 Remove the drive bay

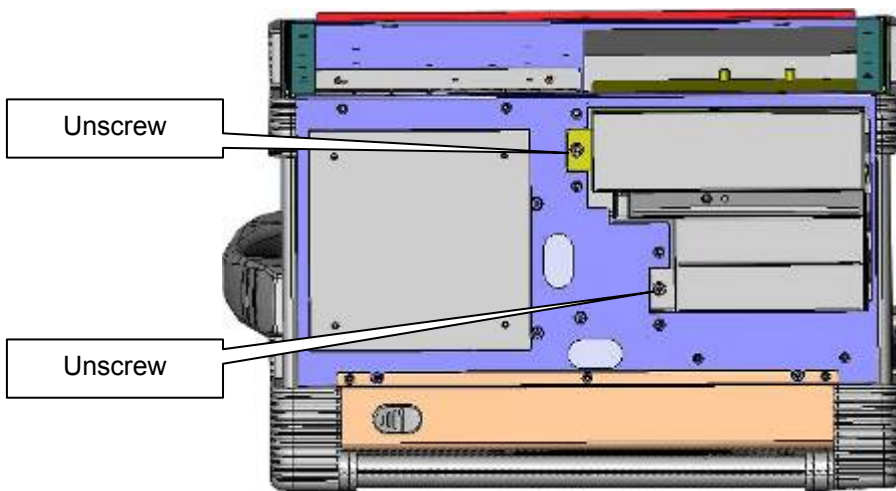

3.3 Slide and move out the drive bay slowly

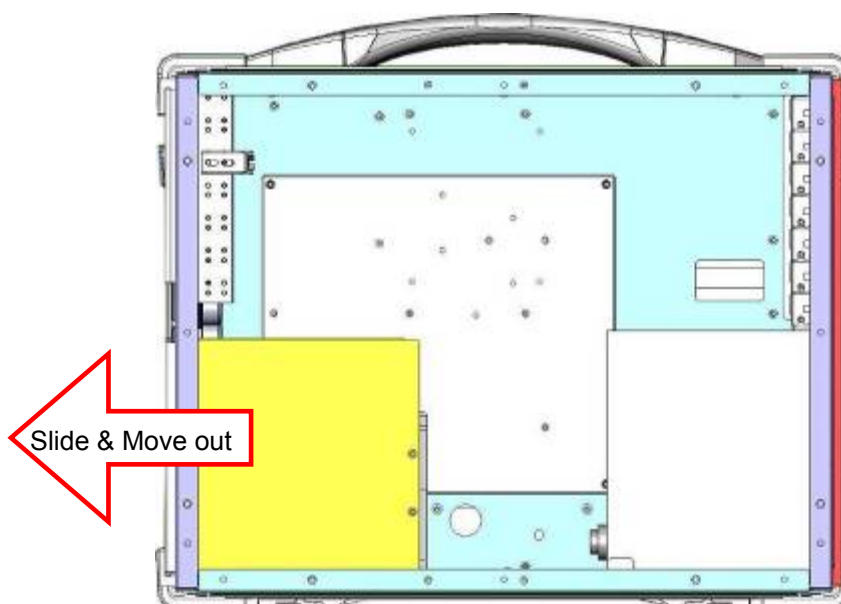

4. Remove The Power Supply

4.1 Remove the left side cover

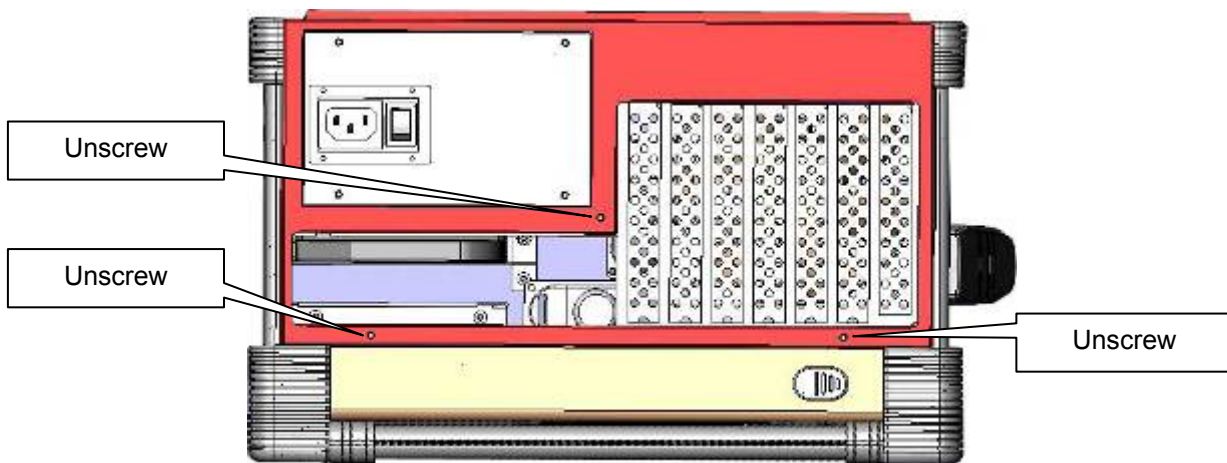

4.2 Remove the fan filter

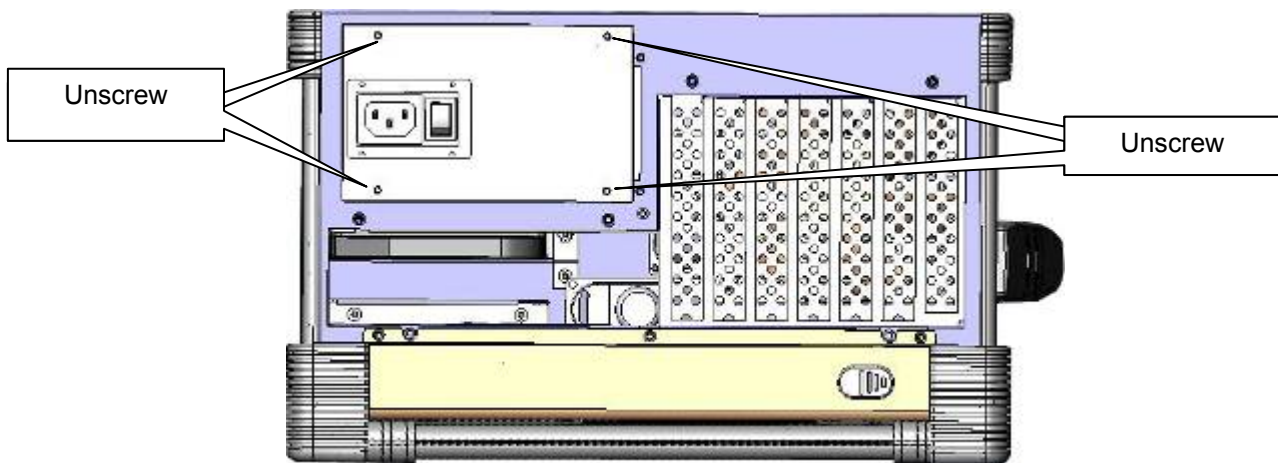

4.3 Slide and move out the PSU slowly

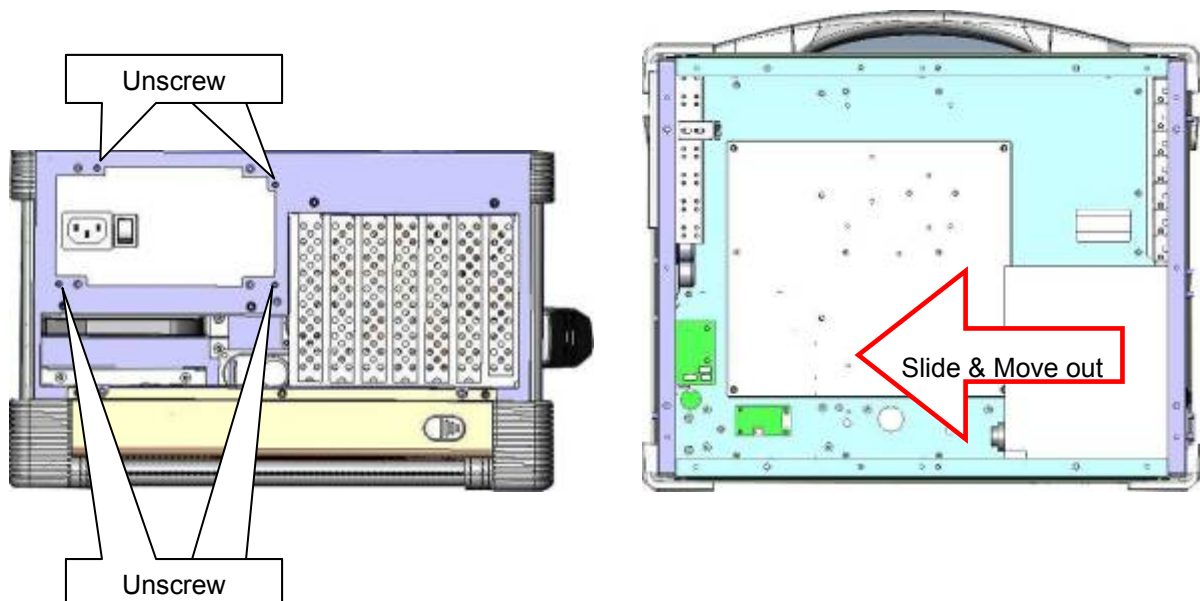

5. Install the proper stand-off matching the standard ATX Motherboard into the chassis and correct I/O plate supplied by board manufacturer and secure it the motherboard onto chassis.

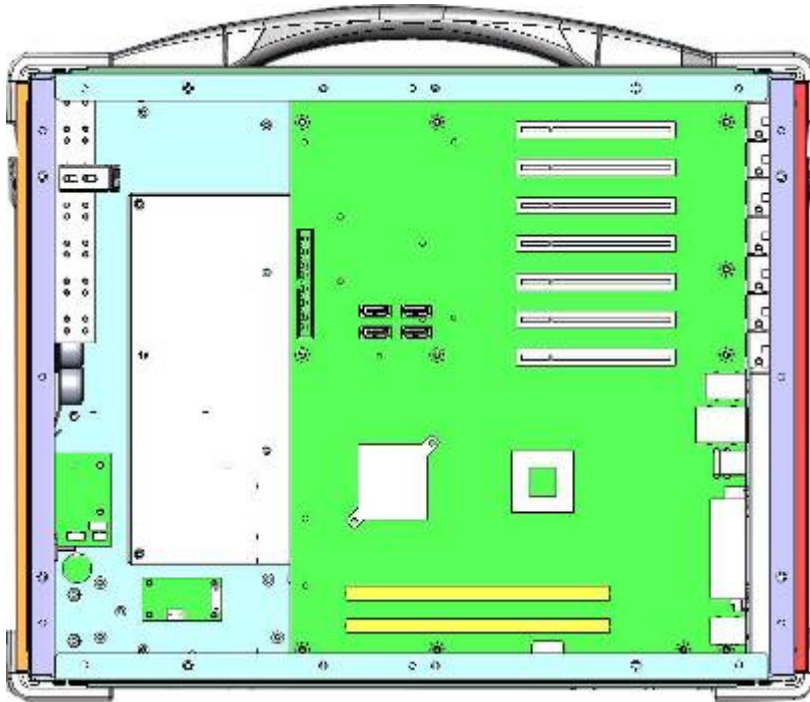

6. Install your add-in card into the appropriate slot

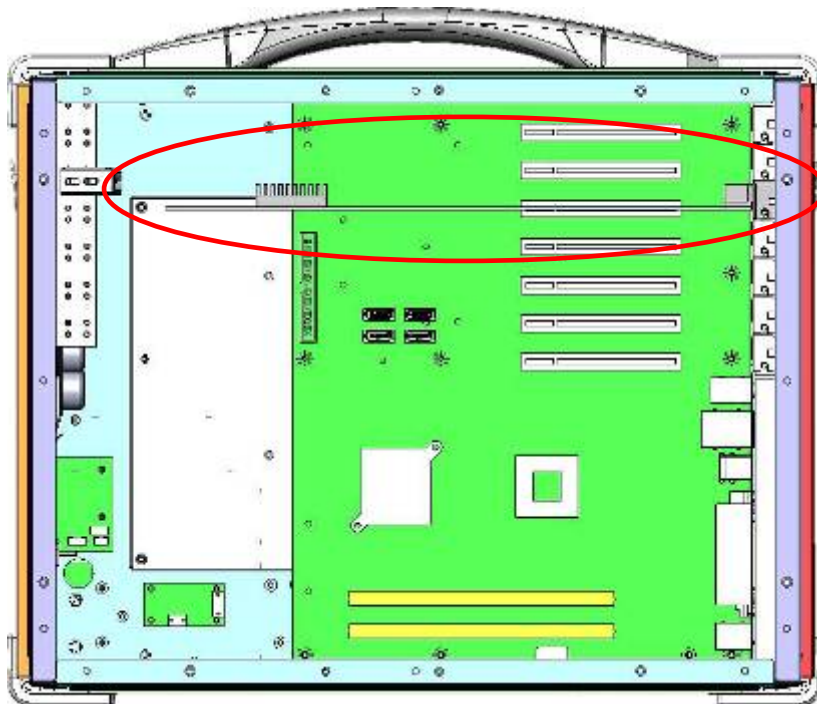

7. Install the 3.5" device and slim DVD-RW into drive bay housing

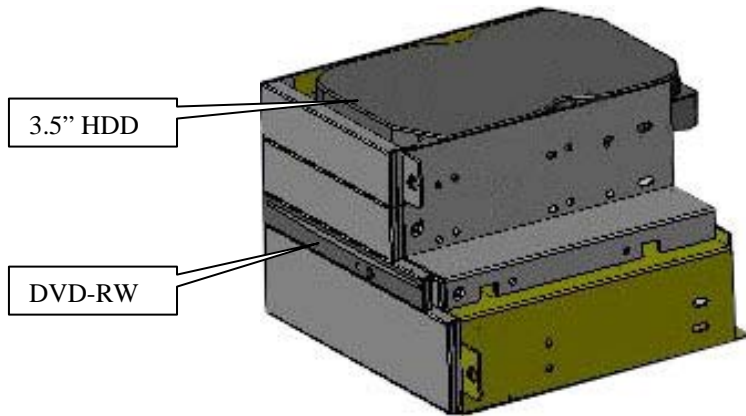

8. Install the drive bay and power supply into chassis

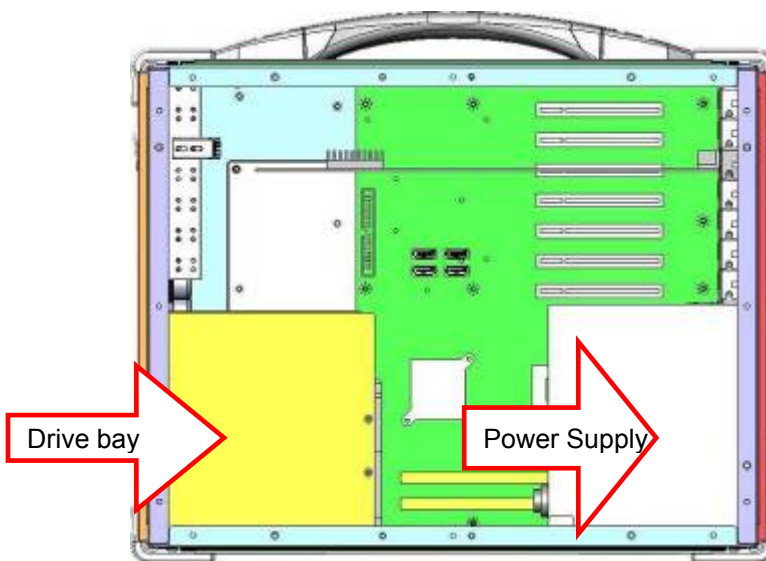

9. Remount the card stabilizer bar and put the rear cover back

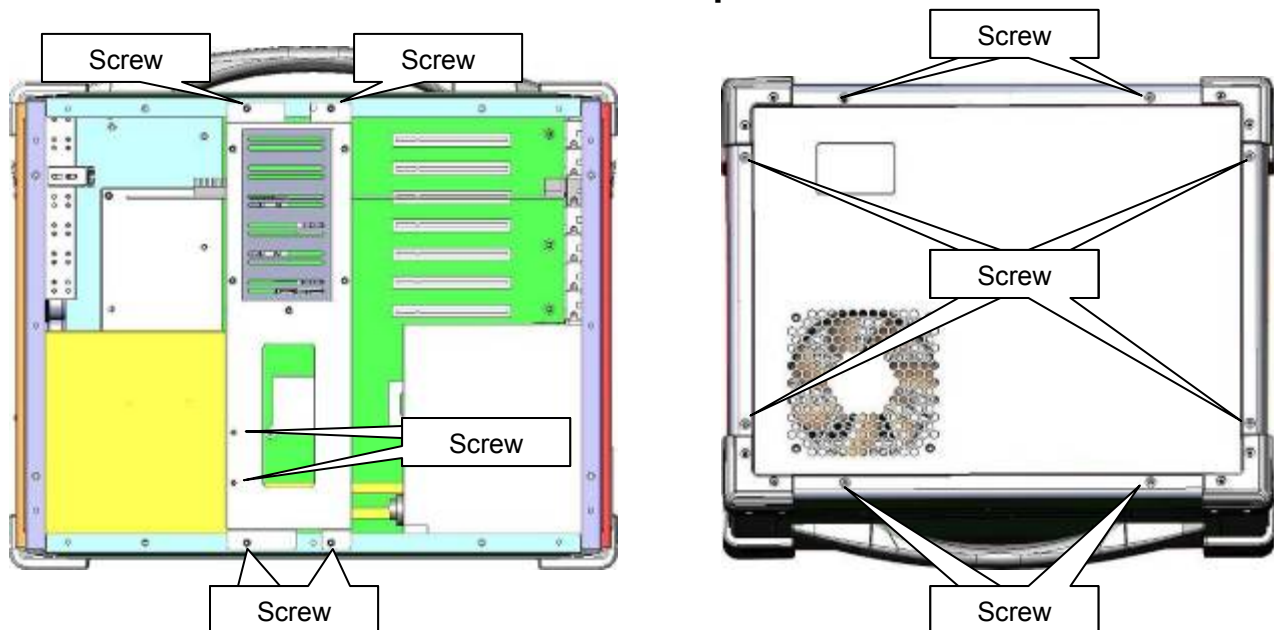

4.0 Software Installation

You can use the built-in DVD-RW to load operating system and additional applications software into the system. Available medium from USB or download can also be possible.

DOS Boot up: DOS boot up requires you to have a version of the DOS installed on hard disk drive or floppy. Depending on the execution sequence you have set in the batch file, you will usually get a DOS prompt after loading.

Window Boot up: Windows boot up requires you to have Windows installed in the hard disk drive. During Windows boot up, you will see a sequence of access to your hard disk drive which will eventually take you into a graphical user interface environment.

Other O/S description: Many other operating systems are available in the market, such as Linux, Windows, Solaris and DOS. These operating systems will behave differently and you should react accordingly.

5.0 Troubleshooting

1. Installation problem:

1. Normally problem with a fail start up is due to installation problem.
2. Double check all the peripheral cards or items you have added to the ARP.
3. Are all the items seated properly?
4. Are all the cables connected back to its original or correct position?
5. Are the items you have added compatible?
6. Before you check for these, turn the computer off and unplug the power cord.
7. Check for 1 thru 5 and then re-power up the computer.
8. Remove all items that were added and re-try system power up.
9. If the system starts now, try inserting 1 new item in at a time and try powering up.
10. Repeat this step until you get the desired result.

2. BIOS Beep Code:

The BIOS beep code indicates error in system initialization. The BIOS of the system board will associate with video and memory error. Please check your video card is properly seated and your memory is installed properly.

3. System Fails to power up:

1. Check you power connection first.
2. Check the main power switch is in the ON positions (I) *If cold switch is available.
3. Press the power button located on the machine.

4. No display (LCD):

1. Check all the proper power up procedure has been taken.
2. Hook up an external LCD to the VGA port, to check if video is present.
3. If video is present on external LCD, check the internal LCD cable connection.
4. Or check your VGA setting to make sure LCD video is enabled.
5. If there is no video on external, check your system to make sure everything is seated properly.
6. If everything is seated properly and still no video, call us for further assistance.

5. External LCD no display:

1. Check to see if you have internal LCD video.
2. Check if your LCD is functioning properly.
3. Check your VGA setting to make sure external video is enabled.

6. Keyboard fails:

1. Make sure the keyboard plug is inserted completely into the portable.
2. Make sure you do not have another keyboard connected to the side I/O PS/2 port.

7. TOUCHPAD fails:

1. Make sure the keyboard plug is inserted completely into the portable.
2. If you have an external PS/2 mouse hook up on the side I/O PS/2 port, the touch pad will not function simultaneously.
3. If your operating system requires and does not load the mouse driver automatically, make sure you have the proper mouse driver loaded.

8. DVD-RW fails:

1. Make sure the CD/DVD is readable.
2. If DVD-RW fails to be recognized during POST, check internal cable fit.